

## Fonema /B/ inicio de palabra

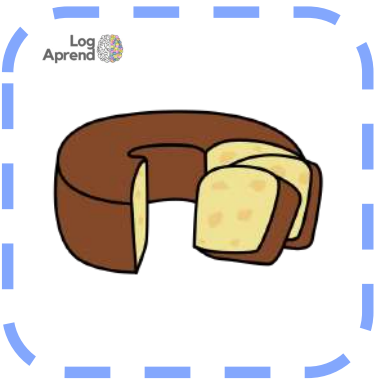

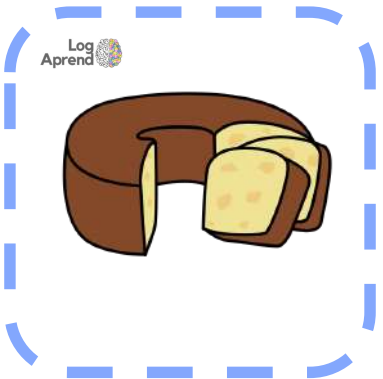

## Fonemas /c/ y /z/ inicio de palabra

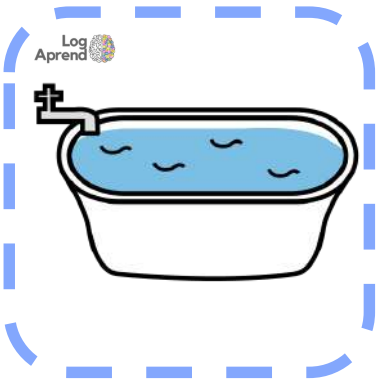
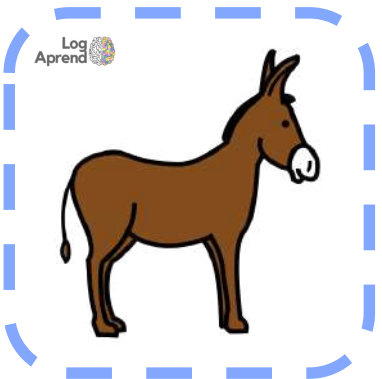
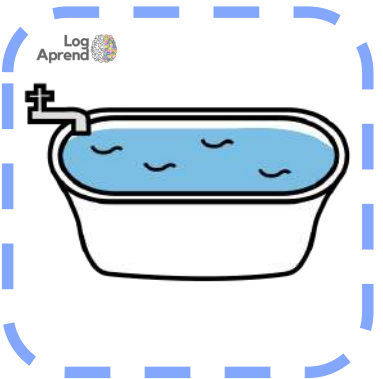
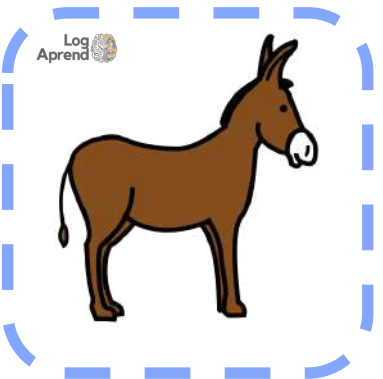
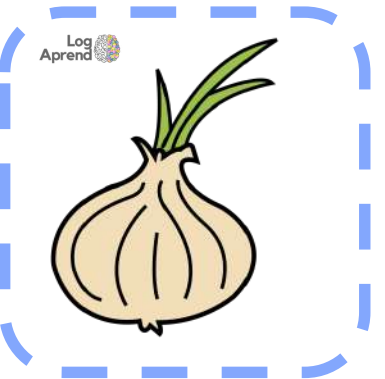
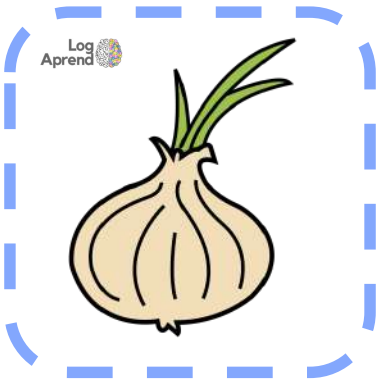
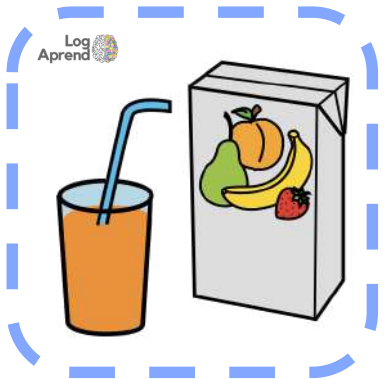
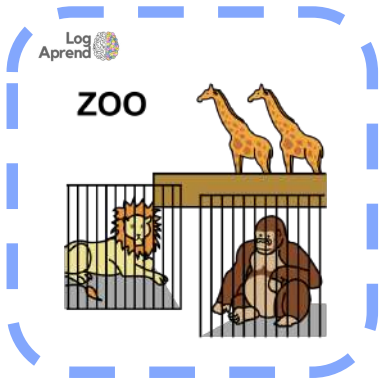
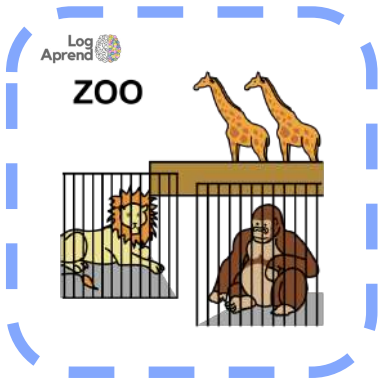



## Fonema /D/ inicio de palabra

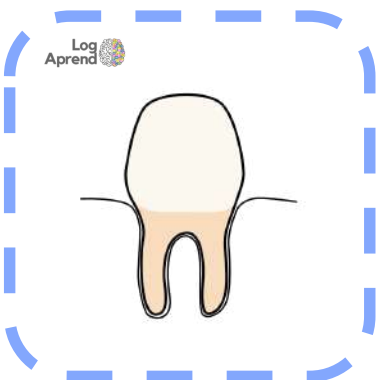
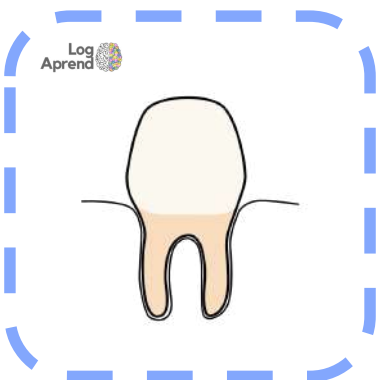
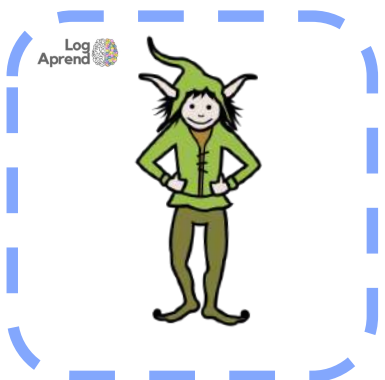
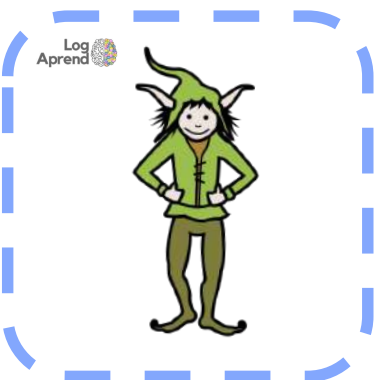
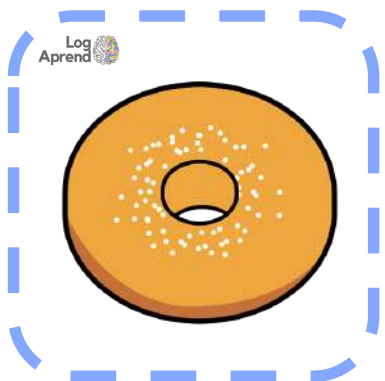
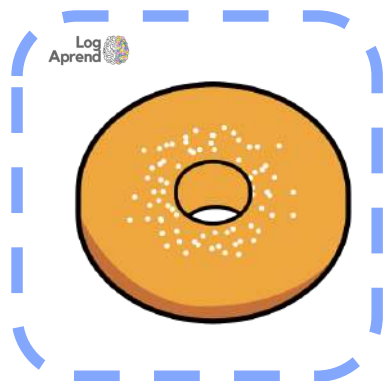
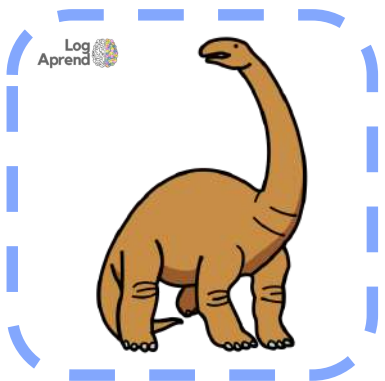
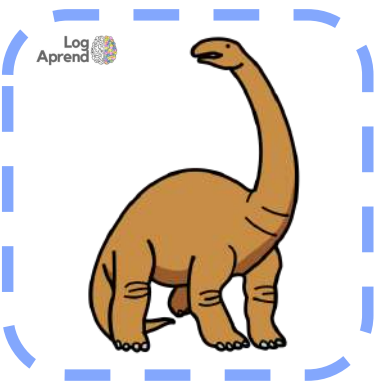



## Fonema /F/ inicio de palabra

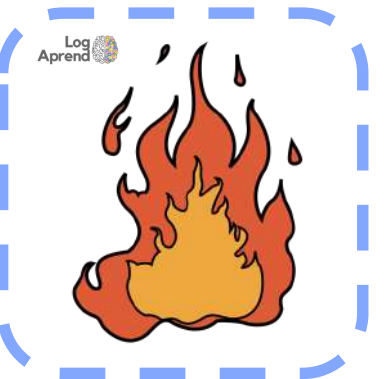
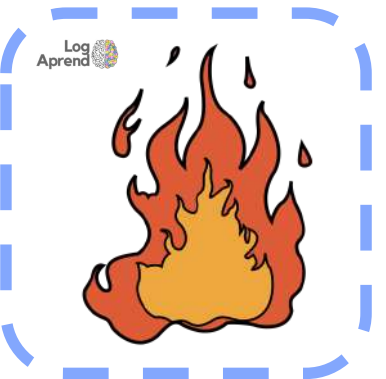
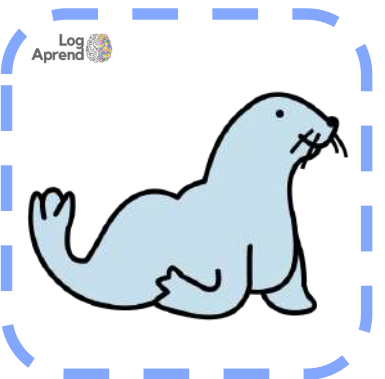
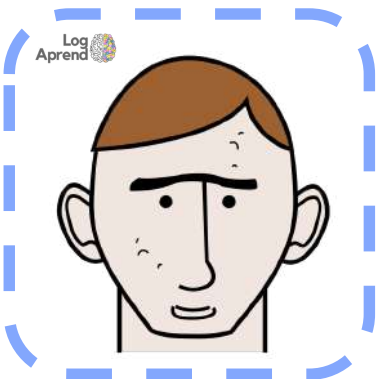
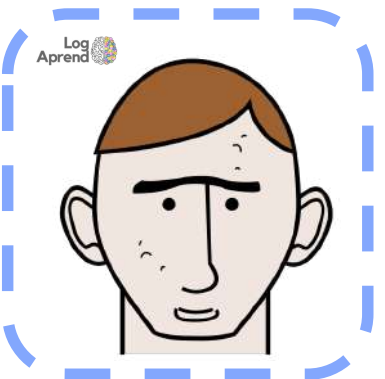
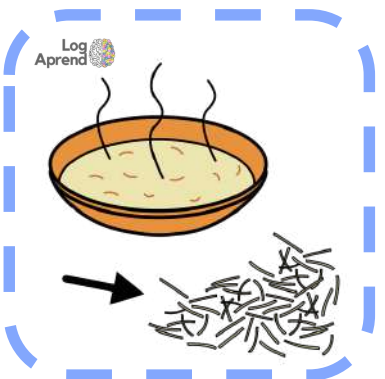
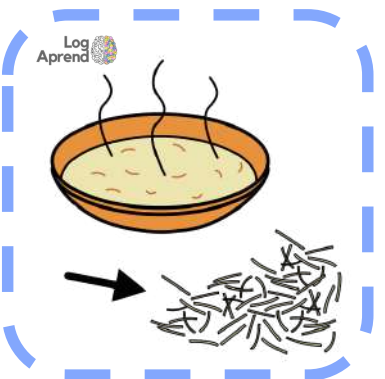





## Fonema /G/ inicio de palabra

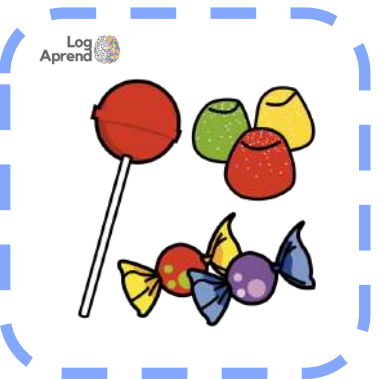
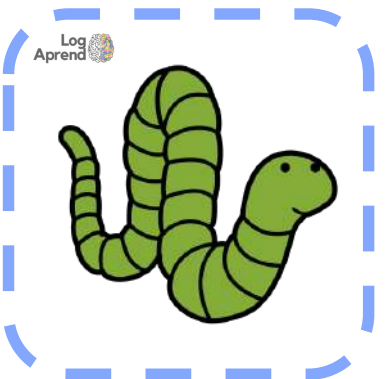
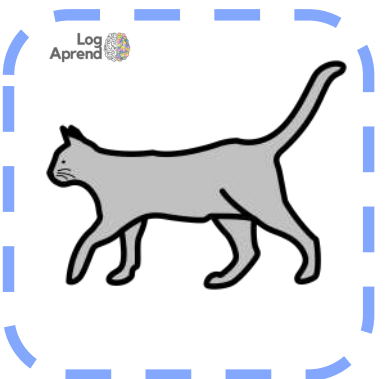
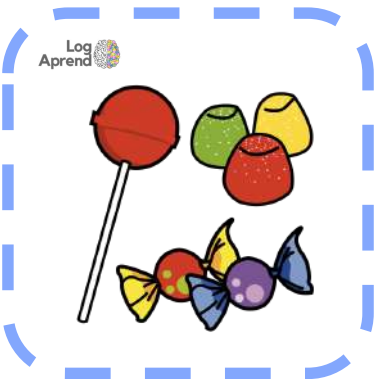
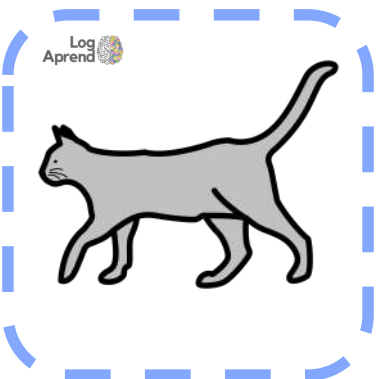
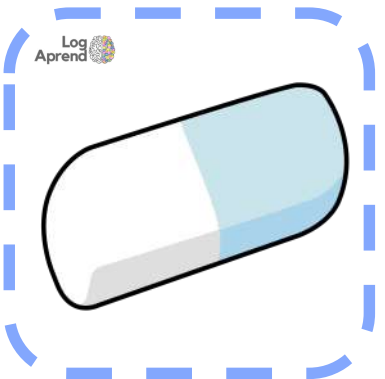
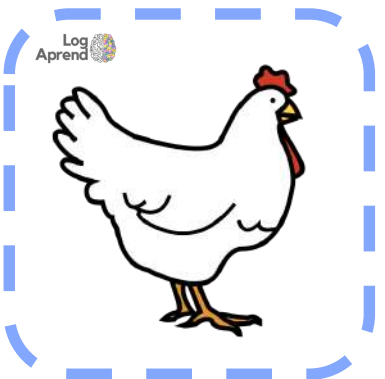
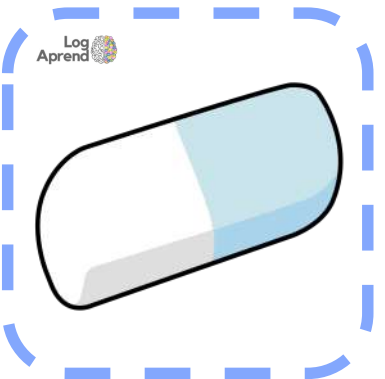
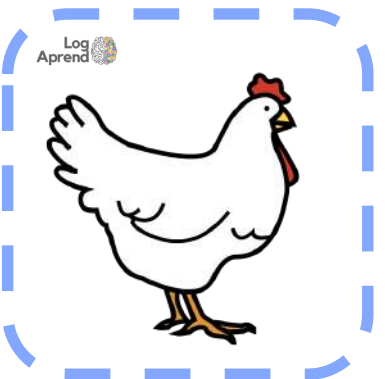
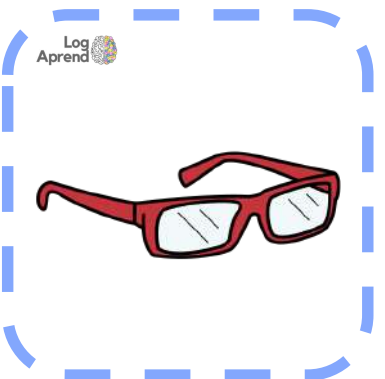



## Fonema /j/ inicio de palabra

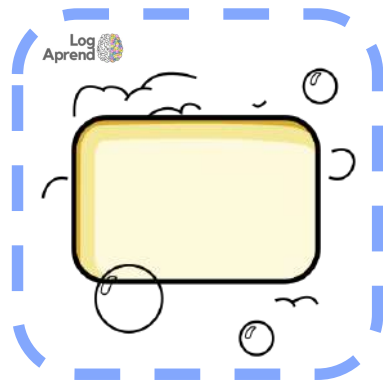
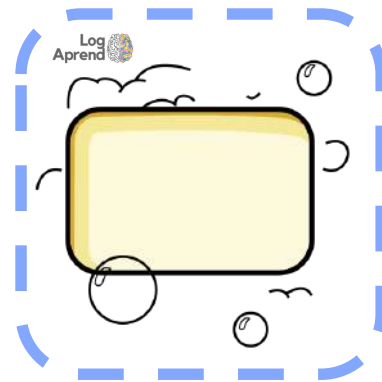
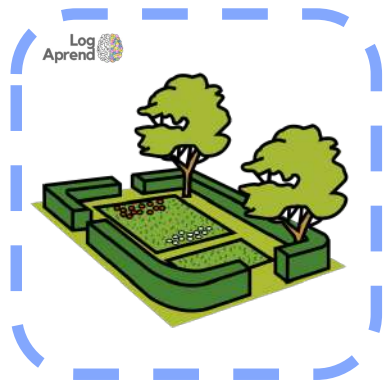
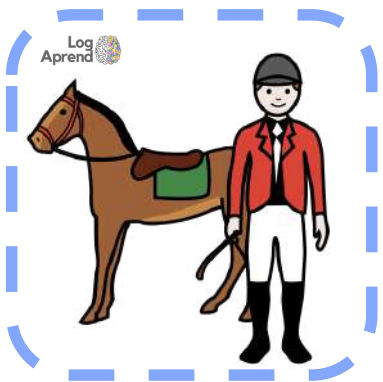



## Fonema /K/ inicio de palabra

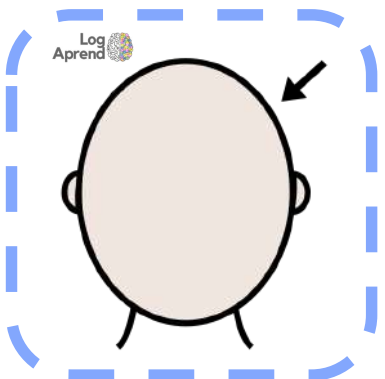
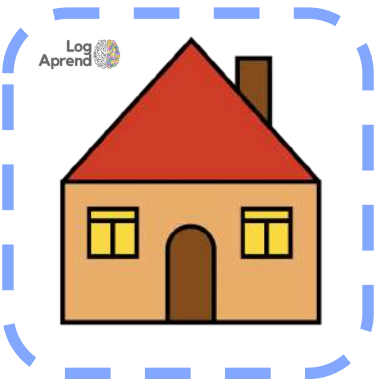
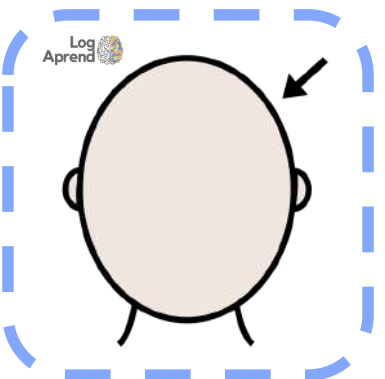
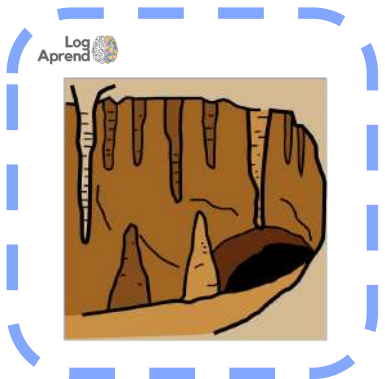
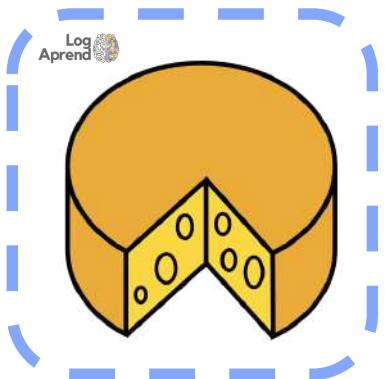
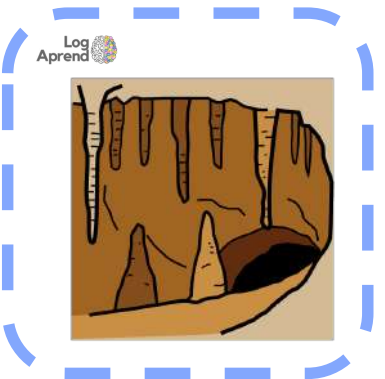
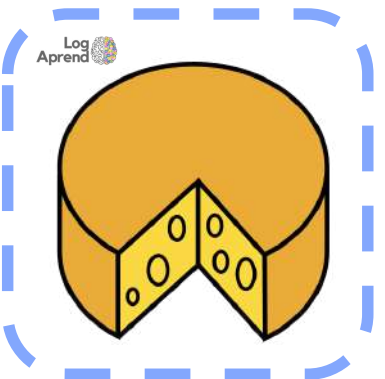
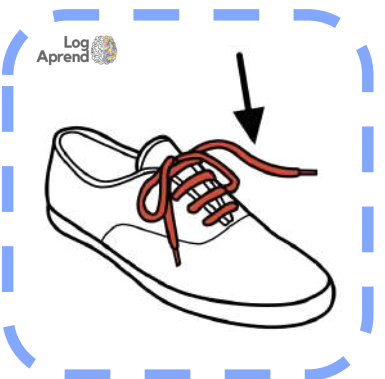



## Fonema /L/ inicio de palabra

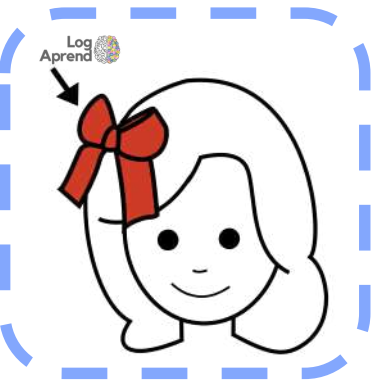
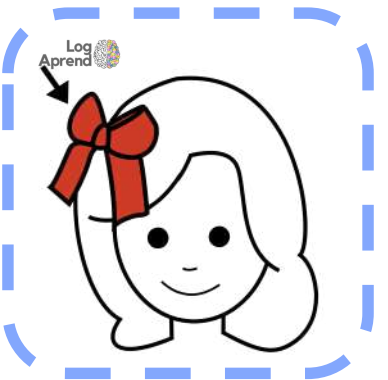
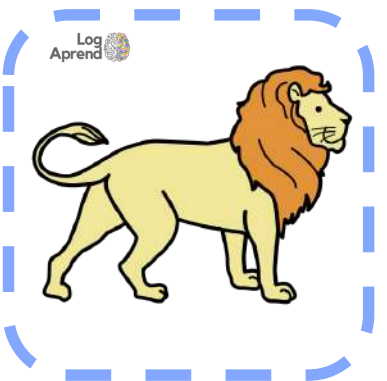
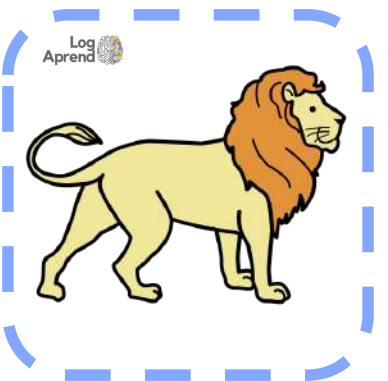
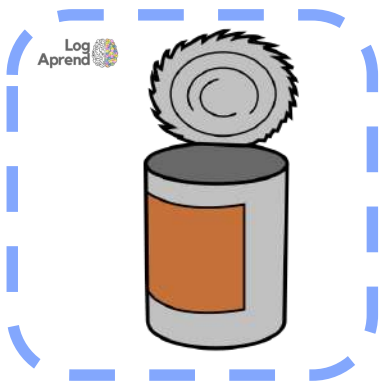
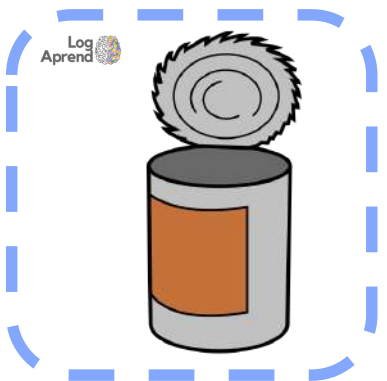





## Fonema /M/ inicio de palabra

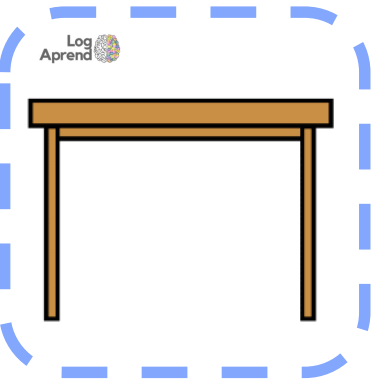
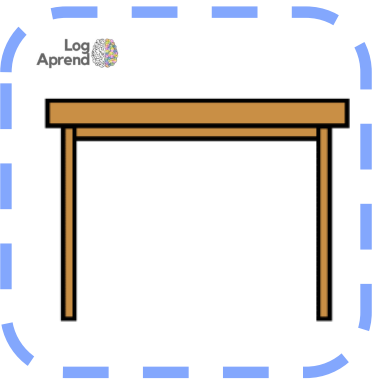
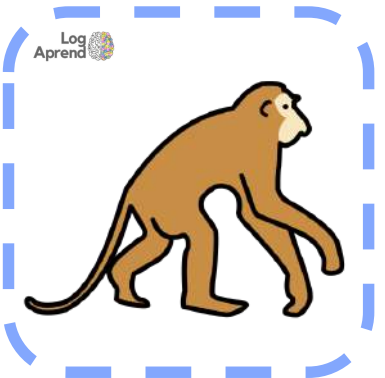
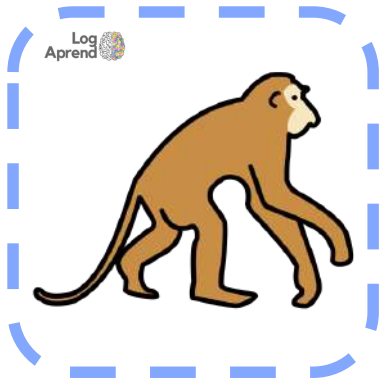
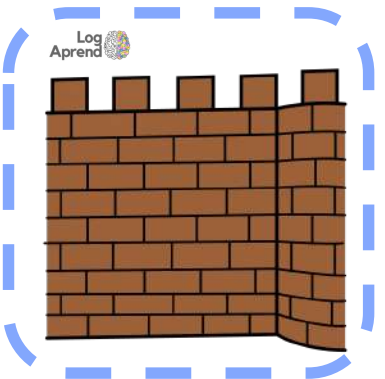
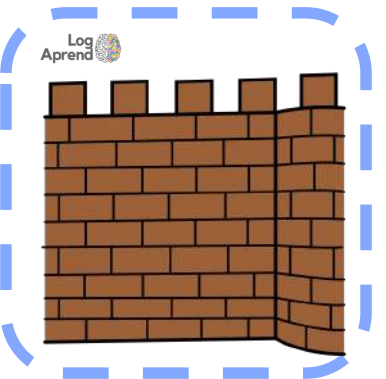
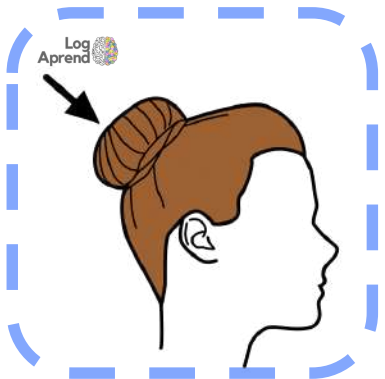



## Fonema /N/ inicio de palabra

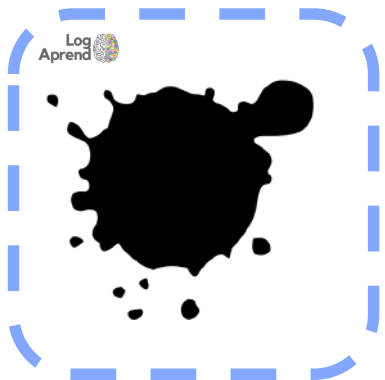
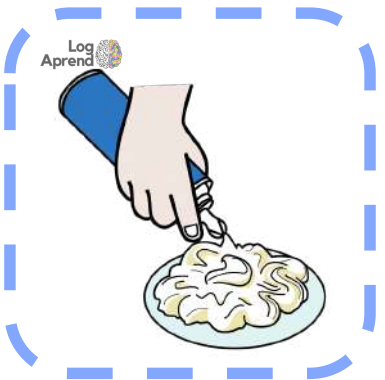
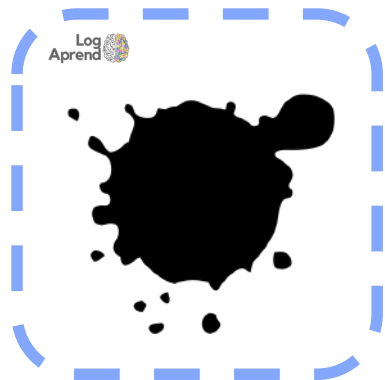
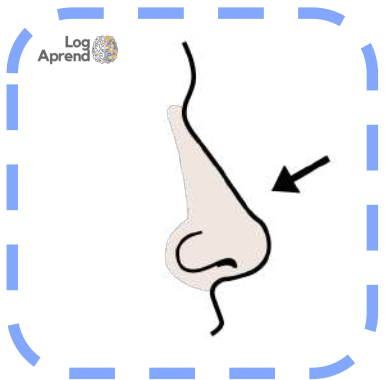
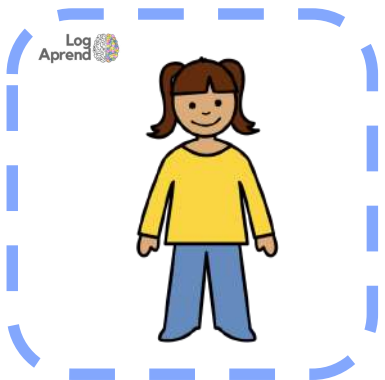
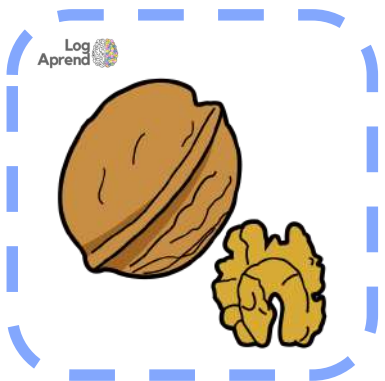
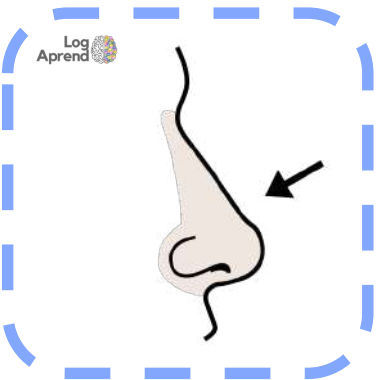
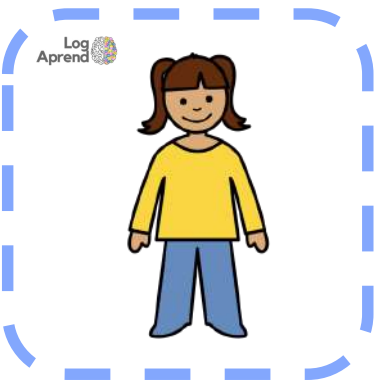
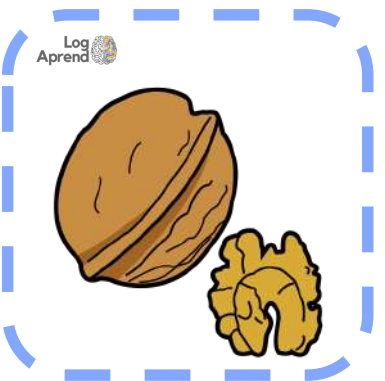



## Fonema /P/ inicio de palabra

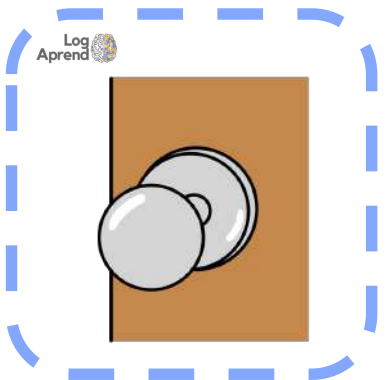
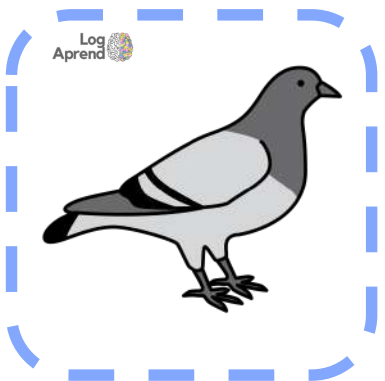
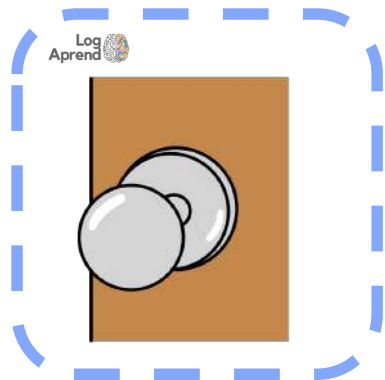
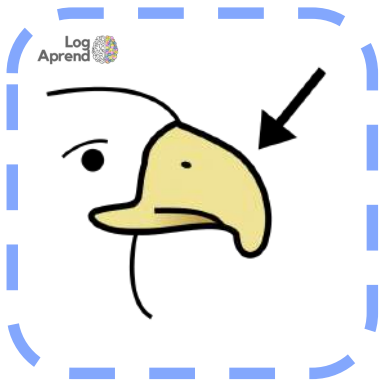
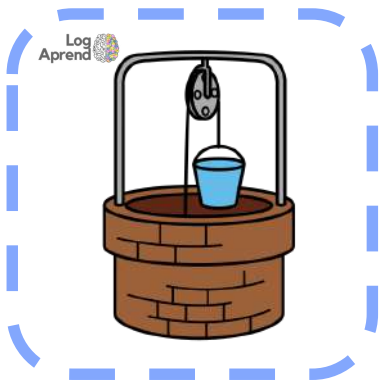
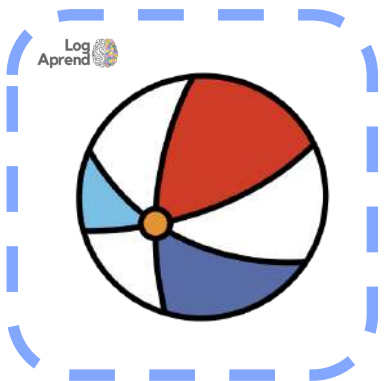
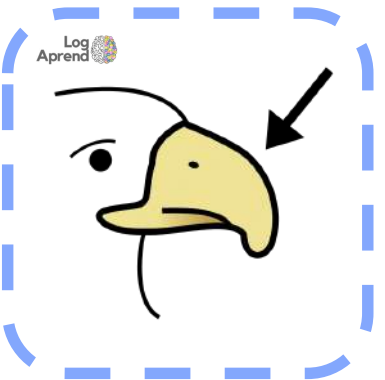
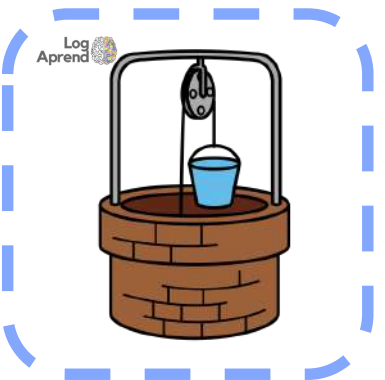
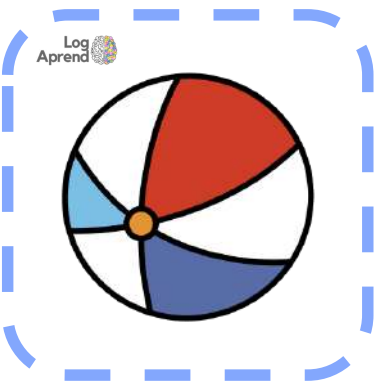



## Fonema /R/ inicio de palabra

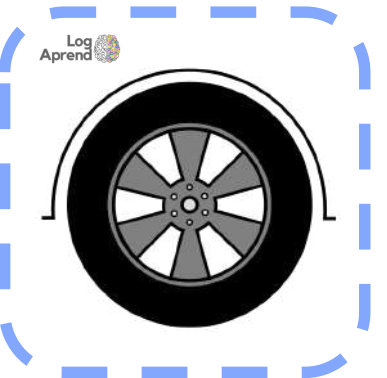
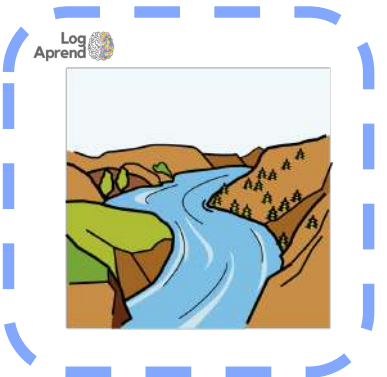
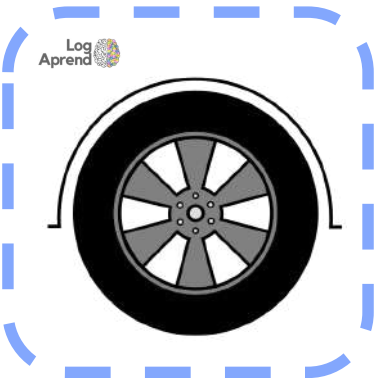
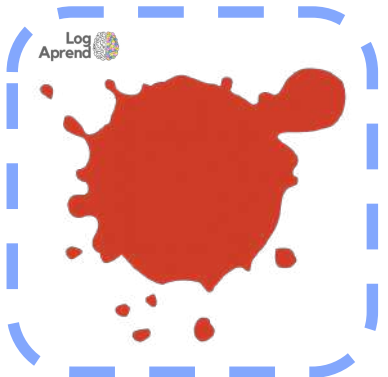
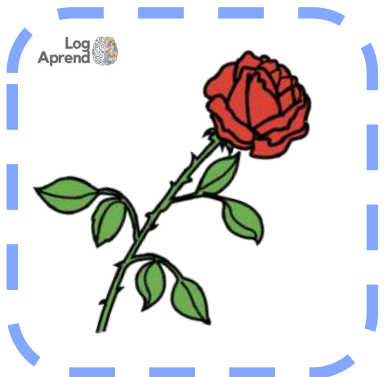
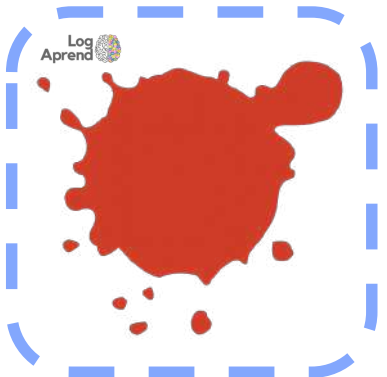
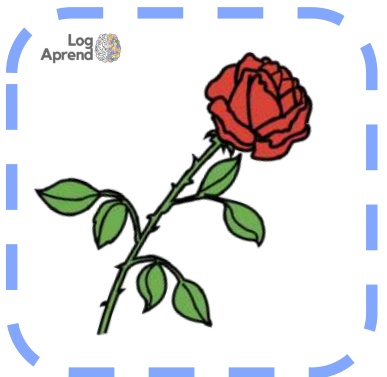





## Fonema /S/ inicio de palabra

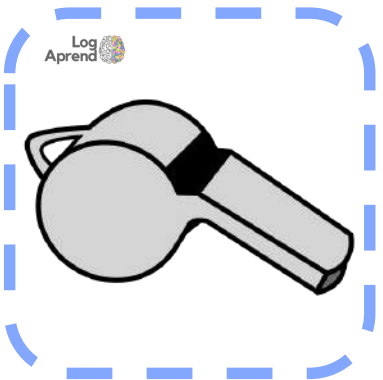
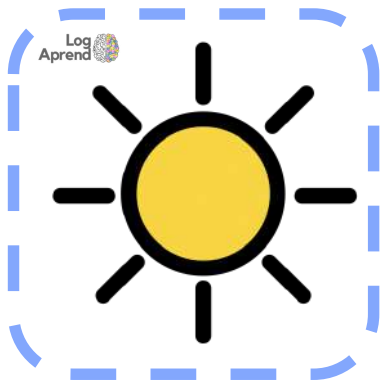
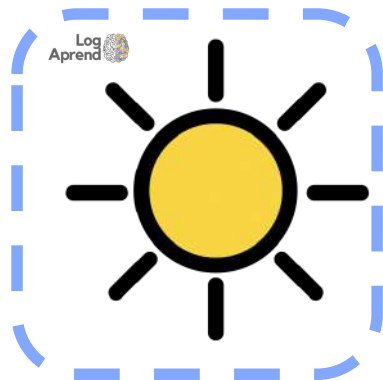
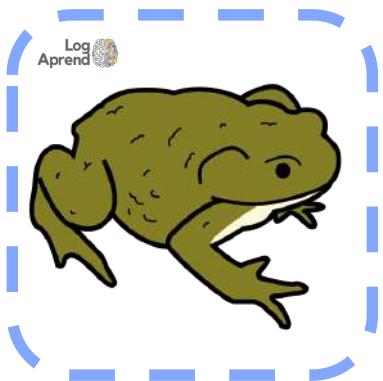
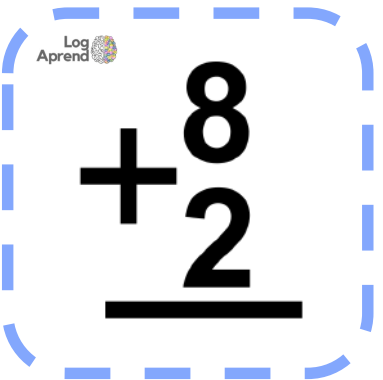
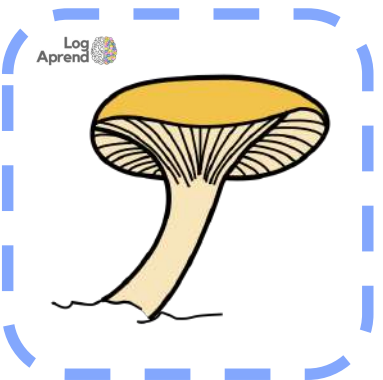
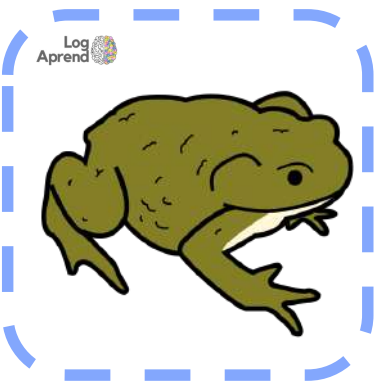



## Fonema /T/ inicio de palabra

